

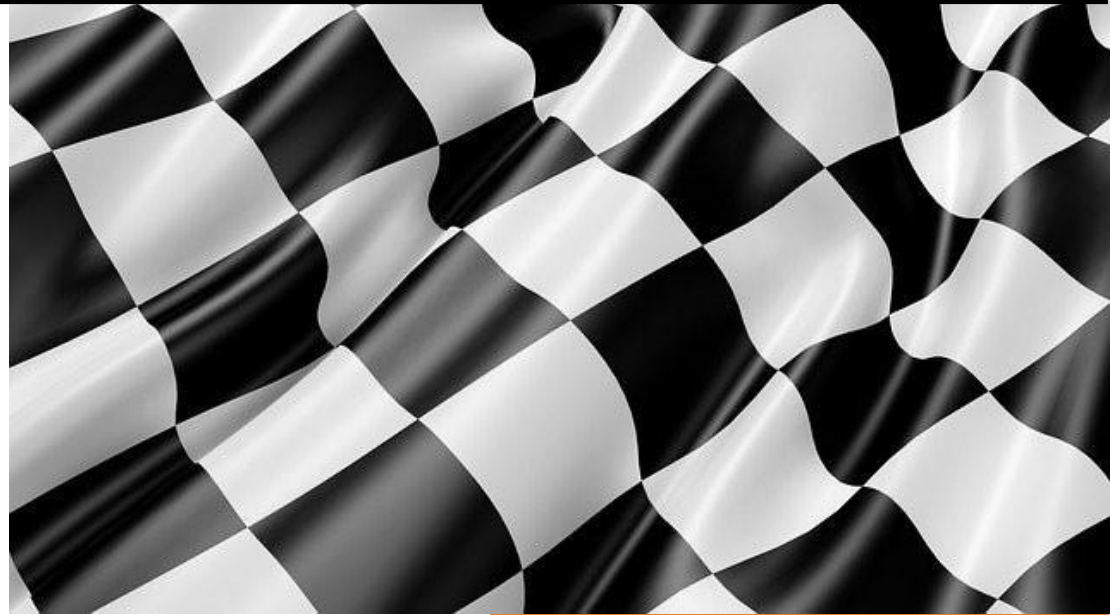

2025

## National Challenge Standing Supplementary Regulations

### ZX10 Masters Cup Circuit Motorcycle Championship



Version 2

21 February 2025

## REVIEW AND AMENDMENTS

Motorsport South Africa (MSA) will periodically review these rules and will present the revised version to all members for agreement to publish the updated version.

Amendments and updates to the rules will be recorded in the Amendment Record, detailing the updated version, date of approval of the amendment and a short summary of the amendment.

## AMENDMENT RECORD

<i>Modified SSR / Art</i>	<i>Date Applicable</i>	<i>Date of Publication</i>	<i>Clarifications</i>
ART 8.1	21.02.2025	21.02.2025	Regulation amendment
ART 10.1 b	21.02.2025	21.02.2025	Regulation amendment
ART 10.18	21.02.2025	21.02.2025	Regulation amendment
ART 10.29	21.02.2025	21.02.2025	Regulation amendment

## Contents

### SPORTING REGULATIONS3

1. CONTROL3
2. ELIGIBILITY4
3. AIM OF THE CHAMPIONSHIP4
4. CHAMPIONSHIP POINTS4
5. RACE SPECIFICATIONS5
6. NUMBERS, SPONSORS, ADVERTISING AND OTHER MARKINGS5
7. PENALTIES, PROTESTS AND APPEALS6

### TECHNICAL REGULATIONS7

8. GENERAL TECHNICAL REGULATIONS7
9. MOTORCYCLE ELIGIBILITY8
10. TECHNICAL SPECIFICATIONS9
  - 10.1 ENGINES/ECU9
  - 10.2 CYLINDERS10
  - 10.3 IGNITION10
  - 10.4 CRANKSHAFT/CONNECTING RODS10
  - 10.5 BEARINGS10
  - 10.6 PISTONS, PISTON RINGS AND RETAINERS10

- 10.7 CYLINDER HEAD10
  - 10.8 VALVES, VALVE CONTROL, CONTROL TIMING10
  - 10.9 INJECTION AND IGNITION11
  - 10.10 AIR FILTER/ AIR BOX/ AIR CHANNELS11
  - 10.11 WIRING HARNESS, ELECTRICAL CONNECTIONS11
  - 10.12 STATOR AND FLYWHEEL11
  - 10.13 STARTER11
  - 10.14 FUEL11
  - 10.15 LUBRICATION12
  - 10.16 WATER COOLANT RADIATOR12
  - 10.17 GEARBOX12
  - 10.18 CLUTCH:12
  - 10.19 EXHAUST SYSTEM:12
  - 10.20 RUNNING GEAR/VEHICLE IN GENERAL13
  - 10.21 FOOTREST13
  - 10.22 FUEL TANK13
  - 10.23 FAIRING/BODYWORK13
  - 10.24 HANDLEBARS13
  - 10.25 FRONT FORKS13
  - 10.26 STEERING DAMPER14
  - 10.27 REAR SHOCK ABSORBER14
  - 10.28 WHEEL RIMS14
  - 10.29 BRAKES14
  - 10.30 TYRES14
  - 10.31 CENTRAL FRAME15
  - 11. EXTRA EQUIPMENT15
- APPENDIX A16
- Appendix B22

## **SPORTING REGULATIONS**

### **1. CONTROL**

- 1.1 These regulations are drafted by the ZX10 Masters Cup committee in consultation with the series sponsors and riders for final approval and publication by MSA. MSA shall have overriding authority in all aspects of the regulations. Every Rider will be personally responsible, to abide by the terms of these regulations. KMSA (Kawasaki Motors South Africa are the official importers of Kawasaki Motorcycles).
- 1.2 If there is a conflict between the MSA regulations and the Kawasaki ZX10 Masters Cup regulations, the Kawasaki ZX10 Masters Cup regulations take preference.

1.3 The Committee reserves the right to make any changes to these regulations. All changes will be published by MSA and noted on the amendment record.

**2. ELIGIBILITY**

2.1 The Championship is open to all holders of valid regional circuit motorcycle competition licences issued by Motorsport South Africa.

2.2 The ZX10 Masters Cup Committee reserves the right to refuse an entry should they determine that the vehicle or the rider does not comply with the regulations.

2.3 All riders must be members of the Kawasaki ZX10 Masters Cup Club. All competitors entering the last event of the racing season, must pay full membership fees no pro rata payments are allowed.

2.4 No rider will be allowed to participate who is also participating/participated at national level in the same year or holds a national licence.

2.5 There are four classes within the Championship:

**Masters:**

Open to riders who are at least 35 years of age before the round that they compete in in 2025 (unless already a member)

Open to female competitors who are at least 30 years of age on 1<sup>st</sup> January 2025

**Grand Masters:**

Open to riders who are at least 40 years of age on 1<sup>st</sup> January 2025

**Veterans:**

Open to riders who are 51 years of age on 1<sup>st</sup> January 2025 or older

**Overall:**

Based on time and position finished from Masters, Veterans and extreme veterans' classes combined

**3. AIM OF THE CHAMPIONSHIP**

3.1 The aim of the championship is to declare a National Challenge Champion in all four classes.

3.2 An average of 6 starters are required to declare a Champion in each class.

**4. CHAMPIONSHIP POINTS**

4.1 Only Riders who take the chequered flag are eligible to championship points. If a rider crashes out and does not complete the race they do not score championship points

4.2 Points will be scored per race on the following basis:

Place	1 <sup>st</sup>	2 <sup>nd</sup>	3 <sup>rd</sup>	4 <sup>th</sup>	5 <sup>th</sup>	6 <sup>th</sup>	7 <sup>th</sup>	8 <sup>th</sup>	9 <sup>th</sup>	10 <sup>th</sup>	11 <sup>th</sup>	12 <sup>th</sup>	13 <sup>th</sup>	14 <sup>th</sup>	15 <sup>th</sup>
Points	25	20	16	13	11	10	9	8	7	6	5	4	3	2	1

4.3 Separation of ties - The competitor with the greater number of first place points in all championship races will be declared the champion. If this does not resolve the tie then the greater number of seconds, failing this, thirds and so on will be used to resolve the tie. If a tie remains, then MSA will declare a winner on such basis as it deems fit.

4.4 Trophies will be awarded for 1<sup>st</sup>, 2<sup>nd</sup>, and 3<sup>rd</sup> place competitors for each class. The organiser has the right to limit the number of trophies based on the number of entries per class.

## **5. RACE SPECIFICATIONS**

- 5.1 The Kawasaki ZX10 Masters Cup forms part of the National Extreme Festival Series of events and shall generally include 8-10 events during a calendar year as per the calendar published by MSA.
- 5.2 A cancelled event may be rescheduled subject to at least six weeks' notice being given to competitors. If it is necessary to cancel an event for extraordinary reasons, damage compensation claims will not be recognised (see GCR 244).
- 5.3 The race will be conducted in accordance with these regulations, as well as the general competition rules and standings supplementary regulations laid down by MSA
- 5.4 The number of grid positions available for each event of the Kawasaki ZX10 Masters Cup shall be determined according to the maximum number of starters for each circuit permitted by MSA.
- 5.5 Entries will be accepted for applicants who applied for membership before the 2007 season, i.e., the founder members. All members that applied after this date will be accepted according to the date; he/she applied as a member (first come first served)
- 5.6 There will be four qualifying sessions and two races of 8-15 laps per event. After each qualifying session and races all motorcycles shall be held in a *perc fermé* for a period to be decided by the C.O.C. but not less than 15 minutes. Each rider is responsible for this. If this is not complied with, then the rider will be excluded from that session and/or race/s (unless the rider has crashed or is stranded out on track waiting for recovery)
- 5.7 Grid positions for Race 1 and Race 2 shall be determined by the means of qualifying times.
- 5.8 In the event of a "wet race" or the start of rain during a race, the provisions of SSR44 (MSA regulations) shall apply.
- 5.9 If a rider has an accident during qualifying or during a race (i.e., the motorcycle is on the ground) the rider concerned shall be permitted to take further part in the qualifying session or race in which the accident occurred, unless prohibited by the marshals from doing so. Subsequently the motorcycle must be re-scrutineered before participation in any further races. If a marshal/official should point out any major defect (e.g., Leaking oil) the rider may not continue with either qualifying or the race. Failure to comply will result in offenders been excluded from the entire event.
- 5.10 Participation in all official rider meetings/briefings is compulsory for all riders. Alternatively, the person responsible for the team is authorised to represent the rider at these official meetings. The penalty for non-attendance will be 5 seconds added to the race time of the next heat participated in. Repeated violations can result in exclusion from the remainder of the 2025 season.

## **6. NUMBERS, SPONSORS, ADVERTISING AND OTHER MARKINGS**

- 6.1 The ZX10 Masters Cup Committee is authorised to make use of indicated areas (Appendix B) on all competing motorcycles for the purpose of the display of the series sponsor advertising material. The display of such sponsor material is a condition of entry to the series and is a scrutineering requirement. Non-defined areas are available for use by personal sponsors. These may not be in direct competition with KMSA or sponsors/partners of the ZX10 Masters Cup and are to be presented to the marketing advisor for authorisation.
- 6.2 By participating in the Kawasaki ZX10 Masters Cup 2025, all teams and riders declare their consent to their utilisation by KMSA or its partners participating in the series for the publicity purposes without remuneration. This also applies to any clothing, pictorial or film material.
- 6.3 All copyrights and picture rights (all formats) regarding the riders, vehicles, and racing events rest with KMSA and the ZX10 Cup Committee.
- 6.4 Competition numbers on the motorcycle shall comply with the provisions of SSR 4.  
Masters Numbers: Black on a white background  
Veterans' Numbers: Red on a white background

- Extreme Veterans' Numbers: Blue on a white background
- 6.5 Dimensions for the digits on the front of the bike
- Minimum height: 12 cm
  - Minimum Thickness: 2.5cm
  - Minimum Width: 8cm
- 6.6 Riders numbers will remain the same for the duration of the rider being a paid up member of the club, unless the rider surrenders the number.
- 7. PENALTIES, PROTESTS AND APPEALS**
- 7.1 All protests and appeals are to be made in writing and in accordance with Part IX of the MSA General Competition Rules.
- 7.2 Should a competitor protest a fellow competitor on a technical matter, the first step will be to Dyno both motorcycles at KMSA to compare the two motorcycles. Should the protested motorcycle require disassembly and it is found that the motorcycle conforms to the technical regulations, then the cost for disassembly, reassembly, all new spares including officials cost required for this process will be borne by the protestor. The extent of these costs will be determined by the master's Cup technical consultant and/or MSA TC in consultation with MSA, at their sole discretion. Failure to comply with this requirement may result in exclusion from the remaining calendar events.
- 7.3 Video footage may be used for all protests concerning racing incidents.
- 7.4 The Clerk of the Course may preclude the further participation of any rider who is felt to constitute a danger to himself or other competitors.
- 7.5 Notwithstanding the provisions of SSR38, a jump start will be penalised by a **30 (thirty) second** time penalty added to the total race time of the respective rider for the race in which the infringement occurred.
- 7.6 During Qualifying sessions, no riders are permitted to coast around the track. If it is found that one rider impedes another rider by coasting, said rider will received a 3 place grid penalty for the first race of the event. Should a rider feel that s/he was impeded they need to submit it to the COC of the event and he will investigate it if s/he hadn't already picked it up.
- 7.7 The COC and ZX10 Masters Cup Committee reserves the right to take disciplinary action against any competitor in respect of instance of unsportsmanlike behaviour, in particular unsporting riding, behaviour damaging the reputation of MSA, KMSA, the Kawasaki ZX10 Master Cup Club or the series sponsors etc. Any transgression as referred to in the rules and regulations will be dealt with according to the disciplinary code of conduct. Any person having their membership revoked in the past will never be able to join the ZX10 Master Cup series again.
- 7.8 The Stewards or the COC when specifically provided for in these Sporting Regulations, may inflict on any competitor one or more of the following sanctions:
- a) A written warning
  - b) A written reprimand
  - c) A fine (as prescribed in the GCR's for the relevant offences)
  - d) A Time penalty via:
    - 1) Adding of time scored in practices/qualifying and or race.
    - 2) 5 second penalty
    - 3) 10 seconds penalty
    - 4) Cancellation of practice/qualifying time(s).
    - 5) Compulsory race start from the back of the grid.
    - 6) Loss of positions in the results.
  - e) Loss of positions on the starting grid.
  - f) Lap penalties
  - g) Exclusion / preclusion.

- h) Technical infringement – Upon recommendation from the TC exclusion from the race and/or deletion of qualifying times.
- i) A 3 place grid penalty will be given to riders who coast or impeded other riders during qualifying.

## TECHNICAL REGULATIONS

**NOTE: Whatever is not specifically allowed in these rules, is disallowed. The OEM / original / Standard (as per workshop manual) parts apply.**

### 8. GENERAL TECHNICAL REGULATIONS

8.1 Prior to the start of each event, the appointed technical consultant will carry out an inspection on each competing motorcycle to ensure they are following the regulations. The competitor/entrant is to abide by the instructions given by the technical consultant. The competitor or the entrant is responsible for ensuring that the motorcycle is compliant with the technical regulations.

**After each session, all bikes are to be left in parc ferme and all riders to exit parc ferme (in the case of intense heat, only the rider or designated mechanic may remain to cool the engine of the bike to a safe temperature)**

8.2 The technical consultant will check the following protective gear:

- i) Full face helmets of approved type (i.e., with 'Double D' fastener), in sound condition and fitting securely. They must be properly fastened and worn by all riders during practice/qualifying and racing. If goggles and/or spectacles are worn with the above, they shall be of 'non-splinter' material.
- ii) Protective clothing as detailed below, in good condition and free from tears, holes or other defects affecting its safety effectiveness, must be worn during practice and racing:
  - a) Leather one-piece racing suit.
  - b) Boots affording adequate protection to feet and ankles.
  - c) Leather gloves.

**Note: No clothing external to the above may be worn unless authorised by the Stewards of the Meeting.**

8.3 Motorcycles found not in compliance with the regulations may be excluded from the competition and further penalties may be imposed in accordance with MSA GCR's and as per point 7 above. In the case of gross and deliberate violation of the regulations, the participant may be excluded from all remaining race events.

8.4 The technical consultant reserves the right to perform spot checks on various motorcycles at any time during the event. The Technical Consultant may impound a motorcycle in consultation with the Clerk of the Course or the Stewards. Competitors/entrants are exclusively responsible for the disassembly and reassembly of the motorcycles as requested by the technical inspector, as well as any associated expenses, should the motorcycle be found to be non-compliant with the technical regulations. Any part/component found not to comply with the regulations, and which is incapable of being brought back into specification in a permitted manner, may be confiscated and retained by MSA to prevent its continued use in events. **Note: Should a rider need to make modifications to their motorcycle (either medical reasons or non-availability of a part) said modifications need to be requested in writing (with supporting documentation) with the committee and voted on by the committee. If approved, an official letter will be drawn up and kept on file.**

8.5 Motorcycles involved in an accident during an event must be presented to the technical consultant immediately after the session in which the accident occurred. A further technical inspection is required prior to the motorcycle further participation in practice/qualifying or

racing. If it becomes necessary during a racing event to reconstruct a vehicle because of extensive accident damage and/or severe engine or gearbox damage or if it must be replaced by a new vehicle, this may only be undertaken with the approval of the technical consultant. In such a case, a further technical inspection of the vehicle is required. No further exchange of vehicle will be permitted during an event. All permitted or required alterations to the vehicle are described in these regulations.

8.6 The TC will have a record of the following at every race event on file:

- a) Rider's details
- b) Bike Entry Number
- c) Bike VIN Number
- d) Engine Number
- e) ECU Seal Number
- f) Engine seal number
- g) Rear shock seal Number
- h) a copy of the dyno run graph when the engine was sealed.
- i) A copy of the rear shock dyno graph.

## **9. MOTORCYCLE ELIGIBILITY**

9.1 The only eligible motorcycles allowed to compete will be the:

2011-2015 ZX10R  
2016-2020 ZX10R and RR  
2021 - 2025 ZX10R

9.2 The vehicle must possess an original Kawasaki vehicle identification number (VIN) on the frame in the respective national format of the supplying country. This may not be subsequently altered. Only vehicles imported by KMSA may be used. No grey or parallel imported motorcycles of this model will be permitted to participate in the championship series.

9.3 Beyond manufacturer tolerances, all alterations are prohibited. Minor changes will be allowed for purposes of close racing and safety.

9.4 All parts, except for those comprising of the racing kit (fairings) and certain specifically defined parts or additionally specified parts from the parts range must be of the same type and year model as the motorcycle, and their condition in use must be within the tolerances stated in the workshop handbook and in the manufacturer's guidelines.

9.5 With the exception of the additional racing kit only original Kawasaki ZX10 parts may be used.

Allowable additional racing kit includes:

- a. After market Racing fairings (any year model may be used).
- b. Braided hoses for both front and rear braking systems may be used.
- c. After market rear sets may be fitted.
- d. Crash protection kits (crash bobbins, mushrooms, etc) may be fitted.
- e. Handlebar ends, handlebar grips, clutch levers and brake levers may be fitted.
- f. Slip on exhaust canisters may be fitted.
- g. A brake lever guard and chain protector (shark fin) must be fitted.
- h. After market petrol cap may be fitted.
- i. Any after market battery may be used, including lithium ion. Not limited to specification make or size.
- j. Quick shifter may be fitted.
- k. After market steering damper may be fitted.
- l. Quick throttles may be fitted
- m. After market chain adjusters, axle bobbins and wheel guides may be used



## 10. TECHNICAL SPECIFICATIONS

### 10.1 ENGINES/ECU

- a. The engine identification number must be visible and legible.
- b. All engines, new or used, will be inspected, and sealed by the technical consultant. No motorcycle will be eligible to race without a sealed engine. ECU's are to be flashed with either the stock model specific factory map or the club approved map. The following options are to be selected by each individual member:
  - Switch off exhaust valve error code
  - switch off intake flap error code
  - Disable purge /pair valve (PAIR VALVE may be removed entirely)
  - enable race dash display
  - Only model specific RPM limits may be used
    - Gen 4 will be set at 13550 rpm
    - Gen 5 will be set at 13650 rpm
    - Gen 6 will be set at 13750 rpm
  - Select/deselect the decel fuel cut (on/off throttle switch)
  - change fan temps
  - change quickshifter kill times and shift patterns - in available models, the "Woolich Race Tools" software may be used to obtain the required settings

ECU will be flashed with the above changes at the beginning of the season, there after the ECU's will be locked and sealed into the bike. No further changes will be made to the ECU throughout the season. Should the ECU show a fault code, only with the approval of the TC can the ECU seal be removed, and faults cleared. Should the ECU need to be reflashed, no changes will be made to the ECU, it will simply have the same map flashed back on to it, locked and resealed back into the bike.

The engine casing of the respective type of original engine must be sealed.

**Boxing of ECU's: This will take place at selected rounds. All ECU's will be marked. Riders will be informed by the TC when they need to present their bikes to the scrutineering bay to change the ECU's. Once ECU's have been placed in the bikes, they will be sealed into the harness with the designated club seal until after race 2. ECU's will be returned to the original owner in parc ferme after race 2.**

- c. The elements of the engine must be in their original condition and within the manufacturer's tolerance range (see workshop handbook and manufacturer's guidelines). Any change effected by removing or adding any material, such as deburring, addition or removal of seals, balancing components, etc. is expressly prohibited unless especially provided for in the present regulations.
- d. The engine ventilation system must remain in its original condition.
- e. All screws for oil outlet screws, oil inlet screws, oil filters, tubes and front brake callipers must be secured with metal wire to prevent accidental opening.
- f. Every motorcycle will be required to be dyno tested and sealed before deemed eligible to partake in the series. An average torque and power curve will be determined per model (2011-2015, 2016-2020 and 2021-2025). A maximum tolerance of 2.5% will be allowed at any point on the dyno curves for power and torque. Any motorcycle failing to comply with these tolerances will be deemed illegal and will have to be proven legal. All cost relating to dyno testing or stripping are for the members' account. The motor (top and bottom and ECU are required to be sealed by the designated 2025 Control rig. (mark club seal) The official seal may only be removed by the TC or a committee member. Any seals that are removed by the rider

without the authorisation of the committee or TC will result in a penalty of starting from the back of the grid from both races. In the event that an engine seal needs to be removed for the engine to be opened, written approval must be obtained from the committee and/or TC. The removed seal must be retained and given to the committee when the bike is taken to be dyno-tested and resealed at KMSA.

## **10.2 CYLINDERS**

- a. Only original parts of the respective model (the addition or treatment of material is prohibited). Dimensions and weights of the cylinder must correspond to the original parts (see workshop manual and manufacturers guidelines). The addition or removal of material is prohibited.

## **10.3 IGNITION**

- a. Only standard CDI/ECU units, as supplied for the specific vehicle are to be used. No enhancement microchips or additional piggy-back systems for fuelling, timing, ignition, etc. are allowed. ECU to be flashed with a controlled map and password protected by the approved TC

## **10.4 CRANKSHAFT/CONNECTING RODS**

- a. The deburring, addition or removal of material is prohibited. Treatment, polishing or balancing of parts is not permitted.
- b. Dimensions and weights of the components must correspond to the original parts (see workshop manual and manufacturers guidelines).

## **10.5 BEARINGS**

- a. The number dimensions and weight must correspond to manufacturers specifications.

## **10.6 PISTONS, PISTON RINGS AND RETAINERS**

- a. Dimensions and weights of the parts must correspond to the original parts (see workshop manual and manufacturers guidelines).
- b. Only original parts of the respective model, no modifications permitted. The deburring, balancing, addition, or removal of material is prohibited.

## **10.7 CYLINDER HEAD**

- a. Only original cylinder heads. The deburring, addition or removal of material is prohibited, including any modification of inlet rubbers. Dimensions and weights of the parts must correspond to the original parts (see workshop manual and manufacturers guidelines). Only the standard thickness head gasket may be used. The standard thickness per model are as follows:

2011-2015 models = 0.65

2016-2018 models = 0.85

2019-2025 models = 0.80

## **10.8 VALVES, VALVE CONTROL, CONTROL TIMING**

- a. The diagram must correspond to the original diagram without modification. The valves, camshafts and the entire valve control with all parts must be in their original condition and may neither be altered, repositioned, or polished. Dimensions and weights of the parts must correspond to the original specification (see workshop manual and manufacturers guidelines).

### **10.9 INJECTION AND IGNITION**

- a. All parts must be in the original, unmodified condition of the relevant vehicle type; standard setting values are recommended.

### **10.10 AIR FILTER/ AIR BOX/ AIR CHANNELS**

- a. All elements of the air intake area, pipes, air filter, air box, sealing components and casings must be in the original condition of the model described and remain within manufacturer tolerances, with the exception that noise reduction flaps in the inlet tract may be removed.
- b. Air filters are free from restriction.
- c. Secondary air valve must be in full operation.
- d. After market air ducts and brackets may be used.

### **10.11 WIRING HARNESS, ELECTRICAL CONNECTIONS**

- a. The wiring harness of the relevant vehicle type must be retained in unmodified form. No additional switches, components or cables must be looped in or added. Shortening in the form of cutting is prohibited. The following alterations to electrical components are permitted/required:
  - Removal of cable connections for rear light from last plug to rear light
  - Removal of cable connections for horn from last plug to horn
  - Removal of cable connections for direction indicators from last plug to direction indicators
- b. The deactivation of the electrical safety system for the side stand by means of bridge-over connector or similar is permitted. In the case of damage caused by a fall during an event, the cable set can be repaired under the supervision of the technical consultant. This must be replaced by an original part at the next event.
- c. The use of lap timers is permitted. The electrical supply of such lap timers may only be provided directly from the battery poles (in line fuse is compulsory) or by connecting the supply provided for the headlight or any unused component power supply

### **10.12 STATOR AND FLYWHEEL**

- a. The stator, its wiring and regulation must conform to the original condition of the specific model and remain within manufacturer tolerances.
- b. The stator must always supply the battery with the relevant current as defined by manufacturer requirements. Additional electrical controls are prohibited

### **10.13 STARTER**

- a. The electrical starter and wiring must be in their original condition and within manufacturer tolerances. The starter must always be able to start the engine.

### **10.14 FUEL**

- a. All motorcycles must use pump fuel available to the general public via normal filling stations. The use of products, additives, or oils to increase the octane level or combustion properties is prohibited.
- b. Separate samples of the fuel used by any competitor may be requested before and/or after a race. These samples must be taken in accordance with the provisions of GCR 240's "Guidelines in respect of fuel sampling".
- c. Notwithstanding the above, the technical consultant (in conjunction with the Clerk of the Course) may request the use of a controlled fuel no later than 30 minutes prior to the

start of a race. Failure to use the controlled fuel when requested shall result in the competitor concerned being prevented from starting the race in question and/or being excluded from the race meeting.

#### **10.15 LUBRICATION**

- a. Engine lubrication and the appropriate oil and oil cooling system are to be maintained in keeping with the original condition of the respective type and must not be altered. The addition of additives to the engine oil is not permitted.

#### **10.16 WATER COOLANT RADIATOR**

- a. The original radiator must be used in unmodified form. A permanent metal protection grid may be mounted at the air inlet side of the radiator to prevent damage from debris. No anti-freeze additives may be mixed with the water used in the radiator. Mo Cool radiator additive from Motul (part no: 102222) may be added. Radiator fan must be present.

#### **10.17 GEARBOX**

- a. the undercutting of gears is permitted. Any replacement parts must be the same as the original parts as per manufacturer guidelines.

#### **10.18 CLUTCH:**

- a. Only original/**EBC Clutch** parts or the respective model (the deburring, addition or removal of material is prohibited). The spider springs must be as per the workshop manual and manufacturers specifications. A clutch modification as per specification from KMSA below is:
  - The part number for the anti judder plate is 13089-0003, this plate takes the place of the two small washers which come as the stock washers in the 06 to 09 ZX10's.
  - Once you have fitted this new plate, the clutch stack must be 53.5mm thick otherwise if it is thicker than this, the slipper clutch will be affected, if its thinner than this, then the clutch might slip.
  - What you need to do is remove the complete clutch and rebuild it using the 13089-0003 plate and get the pack thickness correct by fitting thinner steel plates, along with the standard plates of the stock clutch until the thickness is 53.5mm.
  - Thinner clutch plate part numbers are 13089-1084=2.3mm thick 13089-1093=2.6mm thick"
- b. All model bikes may be fitted with a quick shifter.

#### **10.19 EXHAUST SYSTEM:**

- a. The original KAWASAKI exhaust end canister may be replaced.
- b. It is permitted to take the standard exhaust system and replace the internal components thereof with aftermarket parts (gutting)
- c. Standard headers are to be maintained up to the entrance of the catalytic converter thereafter there is no restriction. The lambda sensor must remain, and the exhaust actuator valve may be removed.
- d. In the event of broken headers, the Gen 4 exhaust headers may be used as replacement headers on the other models.
- e. Only in the case of broken headers: If a competitor's stock headers are broken, only by approval of the ZX10 Masters Cup committee, the locally produced stainless steel header system from powersport may be installed. These headers must be marked with the agreed marking.

#### **10.20 RUNNING GEAR/VEHICLE IN GENERAL**

- a. The frame number and the model plate must be easily visible and legible
- b. **The following must be removed:**
  - Rear view mirrors
  - Passenger footrests
  - Number plate holder
  - Number plate
  - Indicators
  - Headlight
  - Side stand

#### **10.21 FOOTREST**

- a. Aftermarket rear sets may be fitted.

#### **10.22 FUEL TANK**

- a. Only as original part of the respective model with all components and inner parts.
- b. Any modification to the fuel tank is prohibited.
- c. The use of retention foam (explo safe) for the entire volume of the tank is recommended.
- d. The fuel tank ventilation outlet, along with radiator overflow pipes (with a non-return valve), must end in one or more firmly attached collection containers with a capacity of at least 200cc.

#### **10.23 FAIRING/BODYWORK**

- a. After market fairing kits must be identical, within reason, in shape and form to any year model 2011 to 2025 standard ZX10R/RR bodywork.
- b. All body parts remaining on the vehicle must be in line with the standard condition regarding the material and form.
- c. Approval may be obtained from the Kawasaki ZX10 Masters Cup Committee for other corresponding parts.

#### **10.24 HANDLEBARS**

- a. Handlebars are free from restriction, any aftermarket clip on handlebars may be fitted.
- b. The hand levers are free from restriction.
- c. All operating parts and handlebar controls such as kill switch etc. must be retained in their original condition and fully functional (unless specified under the acceptable racing kit)
- d. Steering lock and freedom of movement must not be impaired. Driving safety must be ensured.

#### **10.25 FRONT FORKS**

- a. Replacement of main compression springs and oil is permitted.
- b. No modification to the pump or valve is permitted; no additional shims may be fitted or removed. Bump stops may be taken out.
- c. All adjusters must function as original. The requirement is that the front forks are to be the original fork stanchion and outer shell.
- d. No aftermarket forks are to be used for replacement. The adding or removal of material (modification) to any part is not permitted.
- e. The forks may be pulled through by a maximum of 14mm above the top yoke. Forks must operate in the same manner they were designed to operate in as standard.

#### **10.26 STEERING DAMPER**

- a. All models already have a steering damper as standard.
- b. These units may be modified by altering the valving and oil.
- c. Electronic dampers may be replaced with manual type dampers.

#### **10.27 REAR SHOCK ABSORBER**

- a. All rear shock absorbers must be within the specifications of Appendix A and B of these regulations.
- b. Every rear shock absorber to be used for racing must be scrutinized by the clubs appointed shock technician and sealed. Once the shock has been sealed it is not required to be resealed unless the competitor has his shock serviced or checked in which case the shock must be resealed.
- c. All shocks must be sent to the approved technician to be set up according to the club specifications. The technician will then seal the shock in the manner as agreed upon by the Club, the appointed TC and the technicians.
- d. Any motorcycle that has been found before, during or after a race while in parc ferme with an unsealed shock will not be allowed to participate until a sealed shock is fitted, and the competitor will be excluded.
- e. Only the original rear shock which the motorcycle was issued with (with no internal modifications of any kind) or an approved rebuilt rear shock absorber may be used.
- f. The current approved rebuilt shock absorber is supplied by Martin Paetzold from MP Suspension and Alfie Swanepoel of AS Racing.
- g. All adjusters must function as original. Ride height adjustment by the addition or removal of external (shock mounting) spacers is permitted. However, the ride height spacers must not exceed 14mm in total.

#### **10.28 WHEEL RIMS**

- a. Any Kawasaki Standard production wheels can be used on any model (Gen 4 to Gen 6) no carbon fibre lightweight wheels will be permitted.

#### **10.29 BRAKES**

- a. The Front and Rear brake system must remain standard.
- b. The type of brake fluid used is free.
- c. The brake pads must be original Kawasaki pads of the respective type, **or SBS DC or DS,** or EBC pads may be used.
- d. Braided brake hoses are optional for the front and rear.
- e. Only original Kawasaki, **SBS** or EBC Brake discs may be fitted. No other brand or make may be fitted.
- f. Left hand brake adjuster is allowed.

#### **10.30 TYRES**

- a. Only Bridgestone R11 soft compound (once all medium compound stock has been used) or an alternative as agreed between Bridgestone and the committee are to be used. In the event of stock unavailability, an alternative will be announced after the committee have consulted with the tyre supplier.
- b. There is no restriction on the number of tyres that may be used for the Friday qualifying/practice sessions.
- c. The same set of tyres are to be used for Saturday qualifying, race 1 and race 2.
- d. Tyres must be marked before qualifying by the series TC, and the onus is on the rider to make sure that his tyres are marked correctly.

- e. Any defective tyre may be replaced with a tyre of similar wear at the discretion of the series TC.
- f. Tyre branding (decals) shall be compulsory for all competing bikes on the front mudguard, right and left, in a prominent position.
- g. Tyres will be available through the designated ZX10 Masters Cup supplier. Any other sponsor branding deemed necessary by the committee will be required to be displayed by all riders in the designated areas. Non-compliance will mean exclusion from the race results unless clearance is obtained from the series TC before the first race. Display of required sponsor stickers is a scrutineering requirement.
- h. Any make of wet weather tyres is allowed.
- i. Tyre warmers are free from restriction.

#### **10.31 CENTRAL FRAME**



- a. The central frame must remain in its original condition.
- b. In the case of damage to the attachment point between the central frame and the rear frame, the professional repair of these points is permitted. However, any such repairs must be inspected and approved by the series TC.
- c. The rear subframe is to be used as an original part. Riding safety must always be ensured.

#### **11. EXTRA EQUIPMENT**

- a. Data transmissions/radio communication from the rider to the team/pit box, is not allowed.
- b. The use of video cameras is permitted subject to the rider be willing to supply any footage for the purpose of media material towards the club sponsors, marketing, protests, etc.
- c. Timing Transponders: all timing transponders are to be fitted to the top of the front fork or inline there with subject to the approval of the TC. Transponders may not be mounted beyond or behind this point.

**APPENDIX A**

1. Shock is to be opened and set up according to the specifications as listed in the SSR's of the club. These specifications are:

### REAR SHOCK SPECIFICATION CARD

Brand <b>Kawasaki</b>	Model <b>ZX-10</b>	Year <b>2011 &gt;</b>	Date <b>07/03/14</b>
			Setting # <b>1</b>
		Body Cyl Tube <b>40mm</b>	Shaft <b>14mm</b>
<b>GEN 4</b>		<b>RACE SPEC</b>	
Piston <b>Showa - Std</b>	Oil type <b>5 WT</b>		

Compression	Rebound	Compr. Adjuster	Compr. Housing - Std
Std Piston	30x0.10	18x0.30 (3)	Compr. Needle - Std
34x0.30 (2)	27x0.10	14x0.30	Compr. Piston - Std
28x0.20	30x0.30 (4)	12x0.30	
26x0.20	28x0.30	9.5x0.20	Reservoir Cap - Std
24x0.20	26x0.30	10x0.30	Bladder Type
22x0.25	24x0.30		
20x0.25	15x0.20		
18x0.25	18x0.20		
16x0.25	25x0.60		

	Gas Pressure <b>12 Bar</b>	Rebound Setting <b>1 Turn Out</b>

**Changes:** .....





**REAR SHOCK  
SPECIFICATION CARD**



Brand <b>Kawasaki</b>	Model <b>ZX-10R</b>	Year <b>2016</b>	Date <b>15/05/16</b>
Total Length <b>Std</b>	Stroke <b>Std</b>		Setting # <b>1</b>
 <small>PIST 28x8x12M1101</small>	<b>GEN 5</b>	<b>WITH KIT</b>	
Piston <b>PIST 28X8X12M1101</b>	Oil type <b>5 WT</b>	Dyno File <small>#As per master file</small>	

Compression *	Rebound	Comp Check Valve	Compr. Housing - Std
New Piston	Piston Std	24x0.10	Compr. Needle - Std
24x0.30 (2)	24x0.30 (4)	20x0.10	Rebound Needle - Std
10x0.30	22x0.30 (3)	12x0.30	
12x0.30	22x0.20 (2)		Reservoir Cap - Std
20x0.30 (5)	18x0.30 (2)		Bladder Type
	11x0.30		
	18x0.30		
	20x0.30 (4)		

		Gas Pressure <b>9 Bar</b>	
			Compression <b>0.5 Turns Out</b>
			Rebound <b>2.0 Turns Out</b>

**Notes: \* Small Comp ports face toward Comp shims**

Gen 5 and Gen 6 to use the same specifications.

2. Once the shock has been set up to the correct specifications, the shock will be closed and sealed with a signed and dated green sticker, the green sticker is then cover with clear lacquer. A serial number is to be stamped in to the shock to identify which shock was worked on by which technician.

This is the agreed method as discussed by the Appointed Technicians, the TC of the club and the the club.



## REAR SHOCK SPECIFICATION CARD

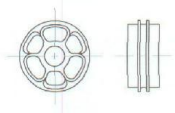

<b>Brand</b> Kawasaki	<b>Model</b> ZX-10R	<b>Year</b> 2016 <	<b>Date</b> 15/05/16
<b>Total Length</b> Std	<b>Stroke</b> Std		<b>Setting #</b> 1
 PIST 28x8x12M1101 o-ring 2x24	<b>Piston dish on compression face</b> 0.25 - 0.30mm  <b>Check Valve side 0.0 dish</b> (no dish)	3 Small Piston Ports face towards Compression shims  3 Large Ports face towards Check Valve	
<b>Piston</b> PIST 28X8X12M1101	<b>Oil type</b> 5 WT - 01309 Öhlins	<b>Dyno File</b> #As per master file	

Compression *	Rebound	Comp Check Valve	Compr. Housing - Std
New Piston	Piston Std	24x0.10	Compr. Needle - Std
24x0.30 (2)	24x0.30 (4)	20 x0.10	Rebound Needle - Std
10x0.30	22x0.30 (3)	12x0.30	
12x0.30	22x0.30 (2)		Reservoir Cap - Std
20x0.30 (1 or 2) only for shimming up float	18x0.30 (2)		Bladder Type
	11x0.30	Rebound check valve - STD	
	18x0.30		
	20x0.30 (1 or more) only for shimming up float		

<b>*Note*</b>		<b>Gas Pressure</b> 9 Bar	
<b>Damping valve housing</b> Torque Setting - 15N/mm			<b>Compression</b> 0.5 Turns Out
<b>o-ring for housing 2x28 NBR70</b>			<b>Rebound</b> 2.0 Turns Out

**Notes: \* Small Comp ports face toward Comp shims**

DAMPING VALVE HOUSING

⊛ NEW PISTON

NUT →

← Adjuster side

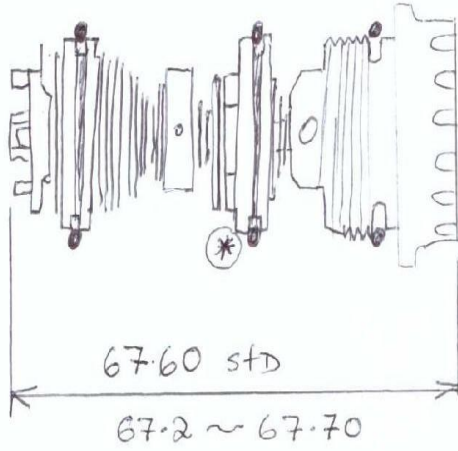

Maestri  
05/2024



## REAR SHOCK SPECIFICATION CARD



Brand <b>Kawasaki</b>	Model <b>ZX-10R</b>	Year <b>2022 &gt;</b>	Date <b>07/02/23</b>
Total Length <b>Std</b>	Stroke <b>Std</b>		Setting # <b>1 - STD</b>
<b>STD OEM Settings</b>	<b>GEN 6</b>	3 Small Ports face are for Compression shims  3 Large Ports face are for Check Valve	<b>WITHOUT KIT</b>
Piston <b>STD Showa Piston</b>	Oil type <b>5 WT</b>	Dyno File  #As per master file	

Compression *	Rebound	Comp Check Valve REB Side	Compr. Housing - Std
24x0.20 (6)	24x0.30 (4)	24x0.10 (3)	Compr. Needle - Std
22x0.30	22x0.30 (3)	11 x 0.30	Rebound Needle - Std
20x0.30	20x0.30 (2)	13 x 0.30	
18x0.30	18x0.30	Domed Alu housing	Reservoir Cap - Std
16x0.30	10x0.30		Bladder Type
10.5x0.30	18x0.30	COMP check valve (std)	
18x0.30		24x0.10 (3)	
		11x0.30	
		13x0.30	
		Alu housing surface domed on 2022 model	

Damping valve housing Torque Setting – 15N/mm		Gas Pressure <b>9 Bar</b>	
			Compression <b>2.0 Turns Out</b>
			Rebound <b>2.0 Turns Out</b>

**Notes: \* Small Comp ports face toward Comp shims**



## REAR SHOCK SPECIFICATION CARD

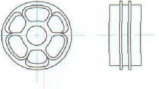

Brand <b>Kawasaki</b>	Model <b>ZX-10R</b>	Year <b>2022 &gt;</b>	Date <b>07/02/23</b>
Total Length <b>Std</b>	Stroke <b>Std</b>		Setting # <b>1 - KIT</b>
 <small>PIST 28x8x12M1101</small>	<b>PISTON DISHED BY 0.28MM ON COMP FACE SMALL PORTS</b>	<b>3 Small Ports face are for Compression shims  3 Large Ports face are for Check Valve</b>	<b>GEN 6  WITH KIT</b>
Piston <b>PIST 28X8X12M1101</b>	Oil type <b>5 WT</b>	Dyno File <b>#As per master file</b>	

Compression *	Rebound	Comp Check Valve REB Side	Compr. Housing - Std
24x0.30 (2)	24x0.30 (4)	24x0.10 (3)	Compr. Needle - Std
10 x0.30	22x0.30 (3)	11 x 0.30	Rebound Needle - Std
12 x0.30	20x0.30 (2)	13 x 0.30	
18x0.30 (2)	18x0.30	Domed Alu housing	Reservoir Cap - Std
	10x0.30		Bladder Type
	18x0.30 (2)	COMP check valve (std)	
		24x0.10 (3)	
		11x0.30	
		13x0.30	
		Alu housing surface domed on 2022 model	

Damping valve housing Torque Setting – 15N/mm		Gas Pressure <b>9 Bar</b>	
			Compression <b>0.75 Turns Out</b>
<b>O-RING AROUND KIT PISTON IS 24X2MM</b>	<b>O-RING AROUND VALVE HOUSING 28X2MM</b>		Rebound <b>2.0 Turns Out</b>

**Notes: \* Small Comp ports face toward Comp shims**

Appendix B

