



2025

MSA RECOGNITION FORM "A"

Technical Regulations – SupaCup Only



Version 1

1 January 2025



REVIEW AND AMENDMENTS

Amendments and updates to the rules will be recorded in the Amendment Record, detailing the updated version, date of approval of the amendment and a short summary of the amendment.

AMENDMENT RECORD

<i>Modified SSR / ART</i>	<i>Date applicable</i>	<i>Date of Publication</i>	<i>Clarifications</i>

RECOGNITION FORM “A”
2025 Technical Regulations
FOR SUPA CUP ONLY

This document specifies items, which affect the eligibility of a vehicle for entry in the above categories of Motor Sport competition, and non-conformity therewith in any single respect will render the vehicle ineligible to compete. It is the responsibility of the competitor or entrant to ensure compliance of the Recognition Form A. Competitors purchasing “used” cars must check that the cars comply with all rules.

No options are allowed except where stated herein or which are authorized by the specific regulations issued by MSA for the above categories, and any changes in the information contained herein for whatever reason, must be advised to MSA immediately they occur.

MSA reserves the right to accept or reject such amendments as being permissible changes to this document, or to request that they be incorporated in separate, revised Recognition form for the vehicle.

The original signed and stamped version of this document is retained by MSA as proof of acceptance and homologation of the vehicle.

The appropriate registration fee must accompany this document when applying to MSA for acceptance, and failure in this regard will result in delay in registration.

It should also be noted that where modifications are allowed in terms of the Regulations, such modifications may not be carried out if they affect any other specification or component which it is not permitted to modify.

Unless specifically permitted in the Regulations, any alteration, change or modification to a vehicle competing in any of the stated categories is not allowed.

Where alternatives are referred to in the items listed in this document, it is sufficient to delete the one(s) not applicable, i.e. YES/NO, AS CAST/FETTLED/MACHINED/AS FABRICATED.

Where standard Volkswagen part numbers are indicated, it must be noted that the last suffixes after the part number may vary. Example: 2Q0 415 627 A (The A might be different.)

MANUFACTURER: VOLKSWAGEN OF SOUTH AFRICA (PTY) LTD (Trading as Motorsport Department)

MODEL: VOLKSWAGEN POLO

ENGINE: Engine capacity 1984 cm³

MANUFACTURING COMMENCED: 2020

MANUFACTURING CEASED: ONGOING

CHASSIS AND COACH WORK

1. MATERIAL AND CONSTRUCTION

1.1. Detail and panels not of steel:

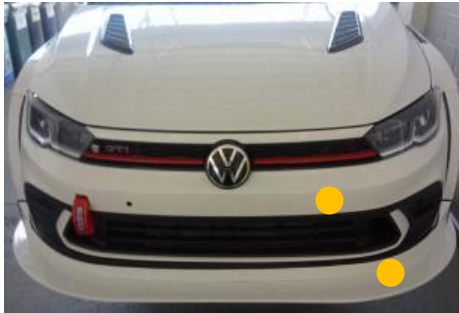

Two types Rear end combinations allowed. Original and facelift.

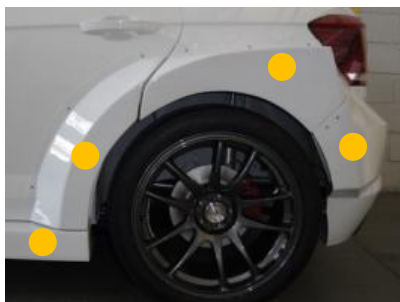

Beeding allowed on body kit edges.

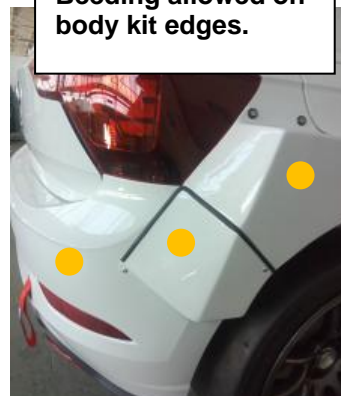

1.2. Excise Mass: 1245kg (including driver)

2. VEHICLE DIMENSIONS

- 2.1. Wheelbase (nominal): 2545mm ± 5mm
- 2.2. Overall length (nominal): 4120mm (Rear Bumper to Front splitter edge)
- 2.3. Front track (nominal): 1860mm ± 5mm (measured between tyre centres on the ground car unladen)
- 2.4. Rear track (nominal): 1810mm ± 3mm (measured between tyre centres on the ground car unladen)
- 2.5. Splitter board : 1845mm ± 5mm (outside edge to edge)
Protrusion from bumper to front edge.
90mm-100mm (measured in center of bumper)
- 2.6. Side sill edge : 1812mm ± 5mm (at rear door to rear door)
- 2.7. Rear bumper : 1770mm ± 10mm (outer edge to outer edge)

3. INTERIOR HEATER

- 3.1. Fitted: No

4. SAFETY CAGE & BODY

- 4.1. Seat belts and Seats to be mounted in accordance with FIA 2006 regulations.
- 4.2. Only bodies prepared with a safety cage by Volkswagen Motorsport or an approved body builder are permitted.
- 4.3. Rollcage material for Chassis 1-11 and 14 is SupaForm (no more available)
- 4.4. Chassis 12, 13, 15 and onwards will be Chrome moly tubing.
- 4.5. The rollcage design is different:
 - 4.5.1. Supaform: Rear structure (Diagonal) and roof bar is 1 tube across for each.
 - 4.5.2. Chrome Moly: V-design. Two tubes each. (Roof and rear)



Supaform



Chrome Moly



Door cross – Design 2 as per FIA Homologation Regulations – Safety Cages.
Drawing SC-11b

5. WHEELS

- 5.1. Material of wheel rim: Aluminium Alloy
- 5.2. Material of wheel centre: Aluminium Alloy
- 5.3. Rim code (supplier): 82160026 Wizard 5100
- 5.4. Rim width: 9.5J
- 5.5. Rim diameter: 18"
- 5.6. Offset from mounting face to inner extremity of rim: ET40mm
- 5.7. Mass without tyres: 10.1kg (incl tyre 21.2kg)
- 5.8. Number of BOLTS: 5 (FIVE) x 100 PCD
- 5.9. 27mm Spacers as supplied by VW Motorsport must be fitted to the front wheels.
- 5.10. 17mm Spacers as supplied by VW Motorsport must be fitted to the rear wheels
- 5.11. Wheel studs are compulsory: Front length = 85mm Rear length = 85mm
Studs may be shortened.

6. TYRES

- 6.1. Tyres approved by the controllers may only be sourced through ATS. Pressure controlling "pop-off" valves and nitrogen may not be used. Only compressed air is allowed to inflate the tyres.
- 6.2. The make and specification of the tyre allowed will be, Dunlop 18" 260/655R18 SLK D20 (Slick). Four (4) tyres will be allowed at the first round run in 2024 and only 2 new tyres per round for SupaCup sprint events will be allowed for the remaining rounds. Should competitors choose to use the SupaCup car in any other category or endurance events, they are free to use another brand and or type of tyre.

The semi-slick tyre will be the WET weather tyre to be used on wet tarmac conditions.
265/35 R18 93W Direzza DZ03G H1 (semi-slick)
- 6.3. Damaged or defective tyres may be replaced in consultation with the TC.
- 6.4. Tyre warmers are NOT allowed
- 6.5. No alteration of the tyre surface/side wall is allowed.
Including physically adding or removing material and/or chemical treatments.
If the Technical Consultant suspects any tampering, he may insist on the tyres being changed for other suitable used tyres that the Technical Consultant approves.

Tyre Table:

SUPA CUP TYRES - 2025

Round	1	2	3	4	5	6	7
Practise	4 new	4 used	4 used	4 used	4 used	4 used	4 used
				2 new		2 new	
Race		2 used	2 used	2 used	2 used	2 used	2 used
	2 new	2 new	2 new	2 new	2 new	2 new	2 new
Used tyres may only be, previously MARKED tyres (Practise or race)							

Four (4) new tyres will only be allowed after Rnd1 for new competitors when they join the series. All competitors will also have new tyres available after high wearing circuits. i.e Round 4 (after Scribante) and Round 6 (after East London) as per the above table. The two new practice tyres must be used in all practice sessions to allow them to be marked as

the two used tyres for qualifying and the races.

If a competitor decides to use no new tyres in the events where they are available, these newly allocated tyres are forfeited for the year and cannot be requested again

7. FRONT and REAR WHEEL ALIGNMENT

- 7.1. Front Camber angle: 4.50 degrees, maximum
- 7.2. Measure with driver seated in the car within an area designated by VW Motorsport Technical Consultants and published on the official notice board of the race meeting.
- 7.3. Method of adjustment: Slider with 4 x M6 Bolts
- 7.4. Castor angle: N / A degrees Fixed
- 7.5. Method of adjustment: N / A
- 7.6. Reference: GCR 226
- 7.7. Rear Wheel Alignment adjustment can be achieved by shimming of the stub axle.

8. STEERING GEAR

- 8.1. Type: Rack and Pinion
- 8.2. Power assisted: Yes
- 8.3. Type: Electrical Column
- 8.4. Upright: Steering arm fits from top into upright (also see point 11.1.11)

9. BRAKE SYSTEM

- 9.1. Dual line
- 9.2. Separate circuits front and rear: Yes
- 9.3. Number of master cylinders: 2(two) Tilton 76-Series
Front & Rear Piston Diameter: $\frac{3}{4}$ (19.10mm), $\frac{7}{8}$ (22.2mm) or 1" (25.4mm)
Master cylinders can be used in any combination front or rear.
- 9.4. Servo assisted: No
- 9.5. Number of servo units: NA
- 9.6. Number of circuits on which servo assistance operates: NA
- 9.7. Type of servo unit(s) – specify manufacture's model number of other reference: NA
- 9.8. Brake pressure regulator fitted: Yes (Tilton – Cable type)
- 9.9. Location, if fitted: Inside Vehicle
- 9.10. Only brake lines supplied by Volkswagen Motorsport will be permitted.
- 9.11. The brake lines must be connected so that the front and rear operate on separate lines.

10. BRAKE ASSEMBLIES – DISC AND CALLIPER TYPE

- | | | | |
|--|---|---|----------------------|
| 10.1. Disc material | - | Front: Steel | Rear: Steel |
| 10.2. Caliper material | - | Front: Aluminium | Rear: Steel |
| 10.3. Ventilated disc | - | Front: Yes | Rear: No |
| 10.4. O/D of disc | - | Front: 380 x 34 | Rear: 272 x 10 |
| 10.5. Disc part # | - | Front: PSC 615 301 | Rear - 2Q0 615 601 G |
| 10.6. No. of wheel cylinders per wheel | - | Front: 6(six) | Rear: 1 (one) |
| 10.7. No. of pads per wheel | - | Front: 2 (two) | Rear: 2 (two) |
| 10.8. Size of piston, Front | - | - \varnothing 38mm (x2) – \varnothing 30mm(x2) – \varnothing 28mm(x2) | |

10.9. Front Caliper

VW Part #: PSC 615 105 & 106 Supplier Part #: VAG08F.M38034.D

10.10. Size of piston, Rear - \varnothing 36.95mm

VW Part #: 2Q0 615 405 Q & 406 Q

10.11. Brake pads part

- Front: FRP3100G (Ferodo) Racing pad
- Rear: 2Q0 415 E (Ferodo) OE pad

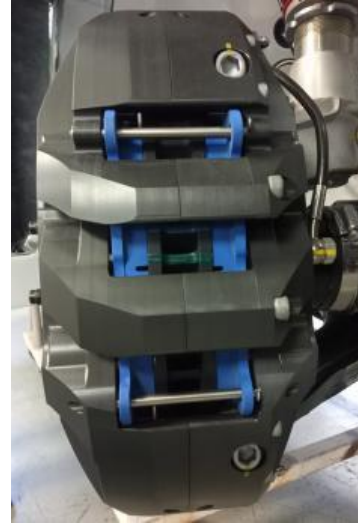

10.12. Heat Plate: A heat plate as supplied by VW Motorsport, may be fitted to protect the wheelspeed wire.



11. SUSPENSION

11.1. Front Suspension

11.1.1. Type: MacPherson strut

11.1.2. Description of control arms and locating members:

LF – Part # PC7 407 151 ASS

RF - Part # PC7 407 152 ASS

11.1.3. Dimensions of springing medium: 200(spring) + 5(spring spacer) + 80(helper) = 285mm

- 11.1.4. Helper spring: Must be fitted at the bottom and main spring on top.
- 11.1.5. Spring stiffness: 120 N/mm or 140 N/mm
- 11.1.6. Coils: Number: Spring 7 & 1/4, Helper 5 & 3/4
- 11.1.7. Diameter of wire: Spring \varnothing 13.6, Helper 4.2x10mm (Rectangle)
- 11.1.8. Make: H&R

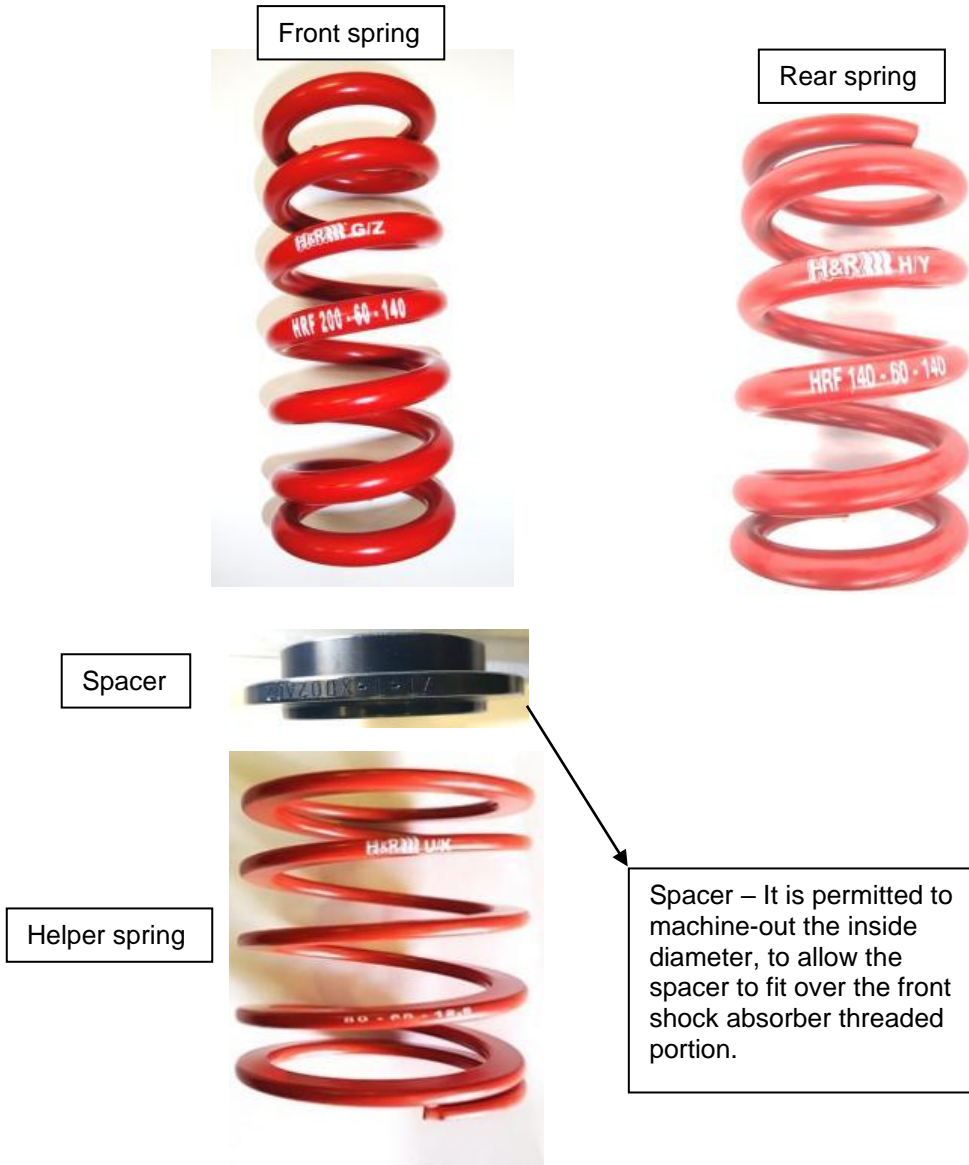

- 11.1.9. Torsion bars: Not fitted
- 11.1.10. Front stabilizer rod diameter: Not fitted
- 11.1.11. Upright: VW Part number: 5Q0 407 253 A / 254 A (Aluminium)



Steering arm fits from top into upright

11.1.12. Camber adjustment by means of a slider system (4.5deg max)

TOP VIEW (Mounted)



BOTTOM VIEW (Mounted)



Camber plate mounted on top of body strut mount.

It is allowed to machine the camber plate slots to achieve more camber (4.5 max)

Caster is built into plate and the offset is towards the rear/inside of the vehicle.

Slider with bearing



Left Front



Right Front



11.2. Rear Suspension

- 11.2.1. Type: Beam axle
- 11.2.2. Description of control and locating members: N / A
- 11.2.3. Dimensions of springing medium: L=140mm, NO HELPER SPRING AT REAR
- 11.2.4. Spring stiffness: 140 N/mm
- 11.2.5. Spring holder/adjuster dimension: Length 72mm, Thread 54.0mm



- 11.2.6. Coils – Number: 5 & 1/2
- 11.2.7. Diameter of wire: $\varnothing 12.5\text{mm}$
- 11.2.8. Make: H&R
- 11.2.9. Torsion bars: Not fitted
- 11.2.10. Rear stabilizer rod diameter: Not fitted
- 11.2.11. Rear spring rubber (2Q0 512 149)

11.3. SPRINGS

The front springs may only be used at the front and the rear springs only be used at the rear.

11.4. Shock Absorbers

- 11.4.1. Only the SAX suspension units as supplied by VW Motorsport may be used.
- 11.4.2. Compressed and extended dimensions of the shocks are as shown below,
Front Shock : Full In – 57mm & Full Out – 202mm (shaft out of housing)
Rear Shock : Full In – 85mm & Full Out – 235mm (shaft out of housing)
- 11.4.3. At the discretion of the Technical Consultant competitors may be required to surrender their shock absorbers. They will then be issued with replacement units.
- 11.4.4. Please note that only the supplier, Pole Position and Volkswagen Motorsport may service these shock absorbers.
- 11.4.5. Shock absorber procedure, in-case servicing is required on a shock absorber or a shock absorber that needs to be replaced on a racing weekend:
 - 1) Shock absorber supplied to VW Motorsport
 - 2) VW Motorsport will supply a replacement unit
 - 3) Shock absorber will be serviced and run on the shock dyno
 - 4) If shock absorber is in-spec, a locking seal will be installed and the shock absorber will go back into spares package

- 11.4.6. Dampers are sealed and may not be reworked.



WARNING:

Shock absorbers are under pressure and must not be opened unless the seal is removed and the pressure released.

- 11.4.7. Any shock absorber found without a seal or the incorrect seal number during a technical inspection, will result in exclusion.
- 11.4.8. Front shock absorber footpiece is machined, at an angle.
- 11.4.9. Rear shock mount bracket



12. ENGINE – 4 STROKE PISTON TYPE

The only permissible engine is the unit fitted by VW Motorsport. These engines will be sealed by VW Motorsport and may **not** be stripped or worked on by competitors or teams. Volkswagen Motorsport reserves the right to exchange a competitor's engine subject to reasonable notice being given. Engines found with seals removed or tampered with will result in exclusion from the results.

As the engines will be the property of the competitor general maintenance will remain their responsibility. Any maintenance work which requires the removal of seals must be communicated to the Technical Consultant who will assess the extent of the work required. Only the designated engine builder for SupaCup will be allowed to rebuild engines when and if this is required. The SupaCup Technical Consultant decision will be final.

12.1. Minimum mass of crankshaft flywheel complete with ring gear: 7.20 kg \pm 0.05

12.2. Part number: PSC 105 266



Note: Weight was done without bolts

12.3. Conrod: When servicing an engine, an optional H-Beam conrod will be allowed.

The weight is the same as the standard part but is significantly cheaper.

Both standard and H-Beam conrods will be allowed.

13. INLET MANIFOLD

13.1. Material: Plastic

13.2. Only inlet manifolds supplied by Volkswagen Motorsport parts department may be used.

13.3. Finish: As supplied – Standard part

13.4. Throttle Body: 06K133062AG Standard part as supplied with the engine.

14. TURBO

- 14.1. Turbo part number: 06K 145 874 N/P
- 14.2. Wastegate throttle valve control element: 06K 145 725 T
- 14.3. Dumpvalve link arm length must be $118.5\text{mm} \pm 0.3\text{mm}$ (overall) see dimensions below.
Length measure against casing 132mm and in open position 141mm . Stroke = 9mm
Measured hot or cold

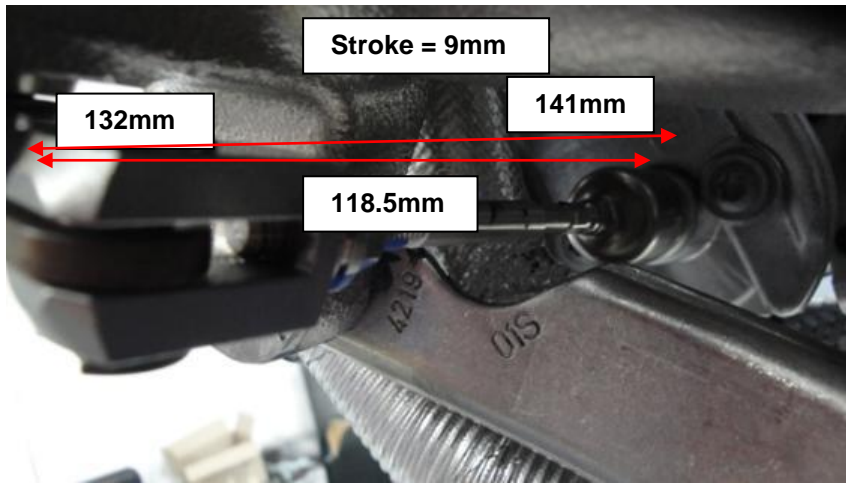

- 14.4. A heatshield as supplied by VW Motorsport may be fitted against the firewall.
- 14.5. Turbo adapter: VW turbo to Toyota engine ($34\text{mm} \pm 1\text{mm}$ thickness)

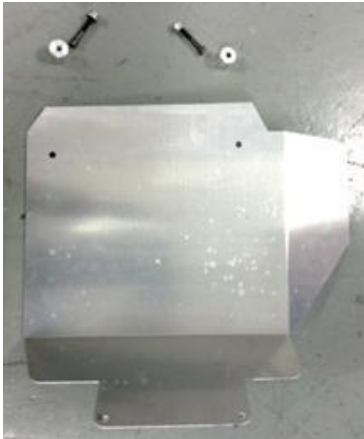

15. BRANCH MANIFOLD

- 15.1. Material: Stainless steel
Flange: Stainless steel
- 15.2. Fastening method: Flange and clamp as supplied by VW Motorsport
- 15.3. Dimension and weight: 4.24 KG
- 15.4. Heat shield may be applied to the turbo and exhaust from the turbo to the front crossmember.

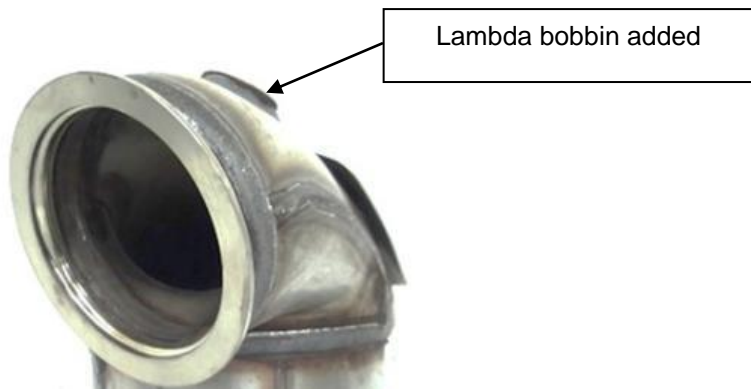
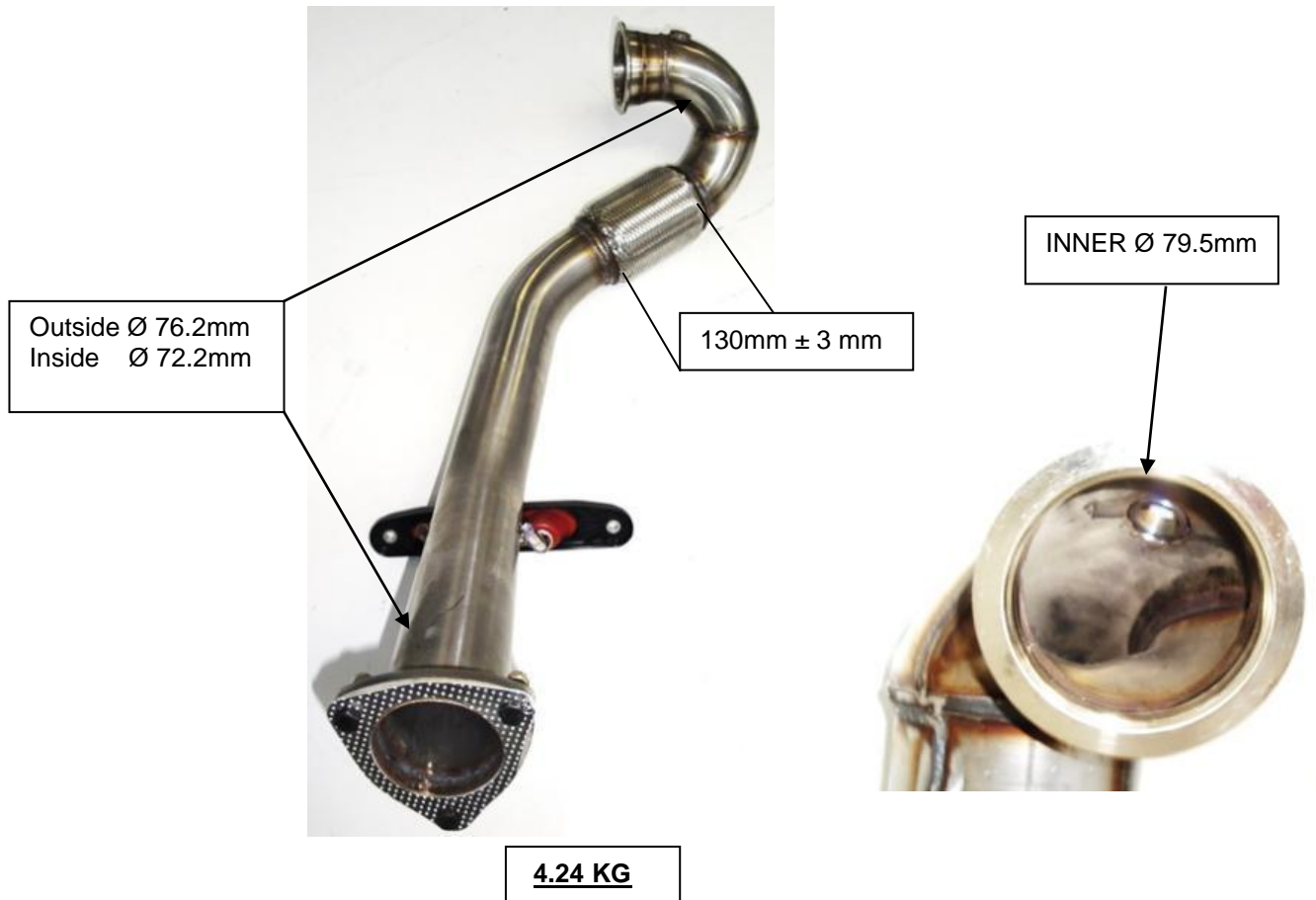

16. EXHAUST SYSTEM AND TAILPIECE

- 16.1. Number of silencers / resonators: 1 (one) – as supplied by VW Motorsport
- 16.2. Length of silencer box: 340 mm
- 16.3. Exhaust centre pipe, weight – 6.14 KG
- 16.4. Exhaust tailpiece weight – 4.32 KG (NEW)
- 16.5. Number of hangers – 3 (three)



17. COOLING SYSTEM

17.1. Radiator (Part No. 5WA 121 251 H)

Location: In frontend of car, in its standard position

17.2. Intercooler (Part No. 5Q0 145 803 T/AD)

Location: In front of radiator, in its standard position.



Number of spray nozzles: 8

Spray nozzle hole size:
Diameter 0.75mm is the
biggest size allowed.

17.3. Front end stiffener:



Stiffner has bobbin welded onto frame to support the splitterboard fixing.



17.4. Front end cradle

Front end cradle cut-out for brake ducts



17.5. Cooling Fan

- 17.5.1. Fan – Part No. 2Q0 121 203 L No. of blades: 9 Diameter: 430mm
- 17.5.2. Coupling: Electric
- 17.5.3. Thermostatically controlled: Yes
- 17.5.4. Thermostat: Original 06L 121 111 P
- 17.5.5. Fixing Method – Original mounting brackets



Cut out for throttle body allowed on plastic surround.

18. FUEL

18.1. Fuel Tank (Part No. 2Q0 201 021 HB – complete with fuel pump)

- 18.1.1. Capacity: 45 litres (with another ± 7 litres available if expansion volume is filled)
- 18.1.2. Location: Under boot floor
- 18.1.3. A spigot connector is allowed as supplied by VW Motorsport to connect the endurance fuelcell.



Standard breather cut-out and replaced with a spigot connector.
Hole in bodyshell allowed for spigot connector to protrude into cockpit.



18.2. Fuel Pump (Part no. 2Q0 919 051 B)

- 18.2.1. Type: Rolling element
- 18.2.2. Location: In tank

18.3. Fuel Control

The Technical Consultant may at any time during a race meeting, in consultation with the Clerk of the Course, drain all the fuel from a competitor's car and replace it with controlled fuel. No fuel may be added to competing vehicles during the official qualifying session.

A minimum quantity of five (5) litres must be able to be drained from any vehicle following the completion of the official qualifying session and after the completion of each race, for analysis purposes.

Fuel samples may be taken at any time during a race meeting.

Fuel samples are measured by using a fuel tester. DIGATRON Model: DT-64 DSPL

A master sample will be taken from the nominated fuel collection point.

Fuel sample reading taken from competitor vehicle, must be the same as the master sample with a tolerance of plus/minus 5 (five).

19. INDUCTION SYSTEM

19.1. Airbox

19.1.1. Part nr: 2Q0 129 601 G

19.1.2. Airbox as supplied by Volkswagen Motorsport

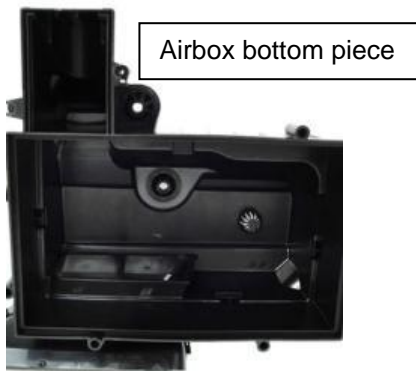
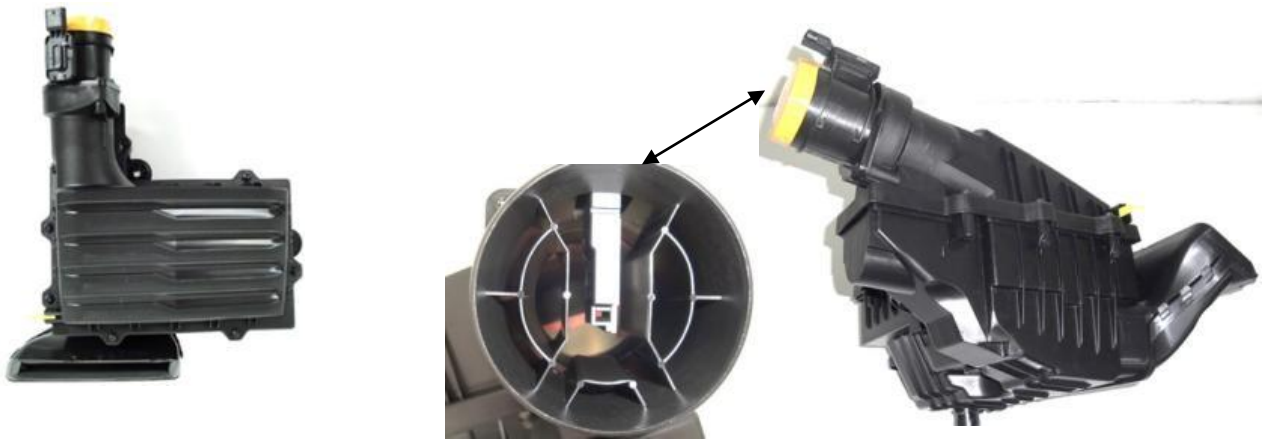

19.2. Air intake duct

19.2.1. Part nr: 2Q0 129 509 A

19.2.2. Standard part: Airflow flap must be closed with cable ties.



19.3. **Air Filter**

19.3.1. Part nr: 5Q0 129 620 D

19.3.2. Filter medium: Paper

19.3.3. The air filter must remain in its original position as supplied.

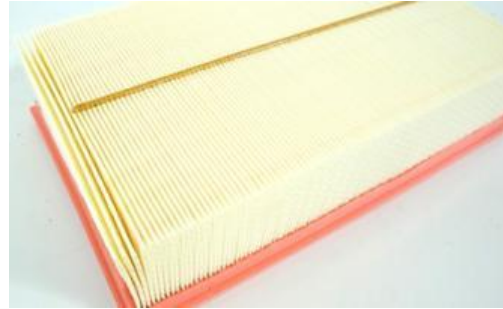
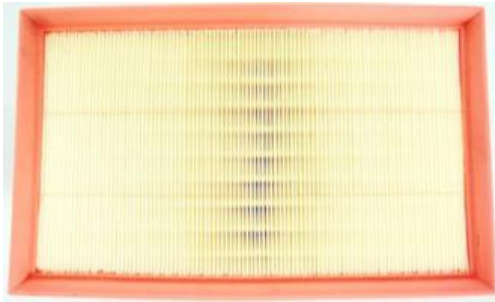

20. FUEL INJECTION

20.1. Make: MoTec

20.2. Type: M142

20.3. Injector Part #: 06L 906 031 A & 06L 906 036 AE

20.4. Location of injectors: Inlet manifold and Cylinder head

20.5. Injector pump type: Type of fuel metering: Electronic, mapped

20.6. Area of flap valve: N / A

20.7. Plenum chamber material: Part of inlet manifold

20.8. Throttle Bodies: x1 per engine

20.9. Layout of fuel injection system:

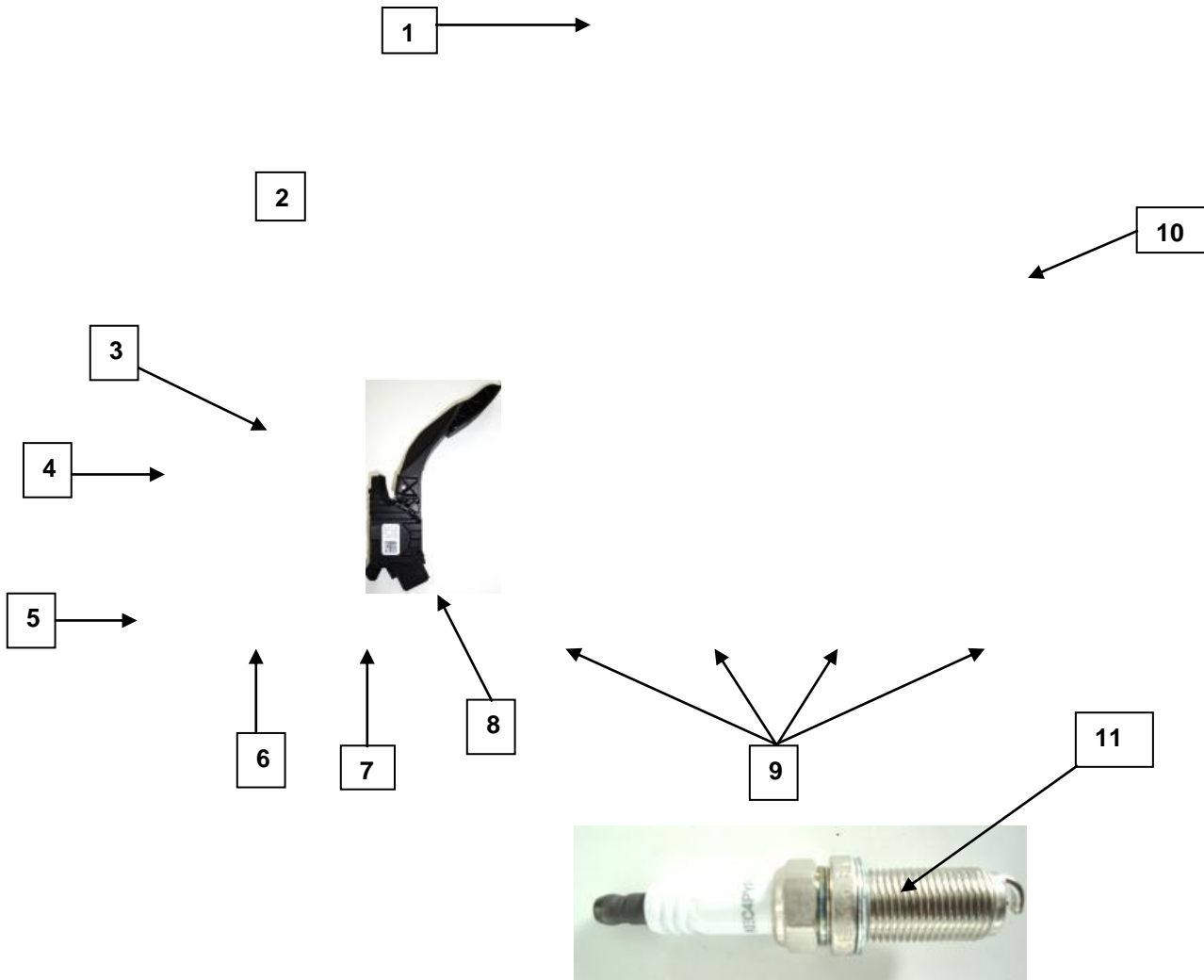

Item #	Part #	Description
1	06J 906 051 F	Pressure sensor - Fuel
2	M142	Electronic Control Unit
3	03G 906 051 E	Pressure sensor - Boost
4	038 906 051 T	Inlet Manifold Pressure Sensor
5	06H 906 433 D	Crank sensor
6	079 919 523 J	Water temperature sensor
7	06H 906 051 K	Pressure sensor - Fuel
8	2Q2 723 503	TPS – Throttle position sensor
9	06L 905 110 K	Coil - Hanshin
10	06L 906 036 AE	Fuel injector – Cylinder head (x4)
	06L 906 031 A	Fuel injector – Manifold (x4)
11	N/A	Spark plugs are FREE

21. LUBRICATION SYSTEM

- 21.1. Type: Wet sump
- 21.2. Crankcase capacity: 5,5 litres Nominal
- 21.3. Oil filter type: Paper element: Full-flow, Part no. 06L 115 562 B
- 21.4. Oil pump type: Chain Drive
- 21.5. Location: In sump
- 21.6. Any Synthetic oil of a viscosity of 5w40 may be used.

22. IGNITION SYSTEM

- 22.1. Description: MoTec M142
- 22.2. Alternator 140A: Part #: 06K 903 024 A
- 22.3. Rev limiter is at 6750rpm and 7100rpm in 6th gear.

23. COIL PACK (Part No. 06L 905 110 K)

- 23.1. Make: Hanshin
- 23.2. Quantity: x4 per engine
- 23.3. Means of timing adjustment: None

24. CLUTCH PLATE (Part No. 04L 141 031 A)

- 24.1. Type: Standard part as supplied by VW Motorsport
- 24.2. Type 240.0 mm
- 24.3. No. of plates: 1 (one)
- 24.4. Weight: 1.10 kg



25. STANDARD PRESSURE PLATE (Part No 06K 141 025 G)

- 25.1. Mass (nominal): $4,85 \pm 0.05$ kg



26. GEARBOX

- 26.1. Make: Part No: PSC 300 050
Gearbox codes: HS001 (numbers run in sequence)
- 26.2. Type: 6-Speed Sequential
- 26.3. Ratios:

TOOTH COUNT

FIRST GEAR	28:11
SECOND GEAR	26:13
THRID GEAR	25:16
FOURTH GEAR	23:18
FIFTH GEAR	22:17
SIXTH GEAR	20:18
REVERSE GEAR	11:20/26:17
FINAL DRIVE	50:13/16

- 26.4. Gearbox is sealed and may only be opened after consulting with the TC.
Should any seal be removed without permission from the registered Technical Consultants, the gearbox will be deemed to have been tampered with and the competitor will be excluded from the results of qualifying and or any race.
- 26.5. All gearbox levers and links remain standard as supplied.
- 26.6. Gearbox oil recommendation: 75W90 Gear 300LS Limited Slip (Motul) Synthetic
- 26.7. Gearbox oil change: At least after ever 3 events
- 26.8. Oil volume: 2.25 litre





- 1.) Reverse lockout
- 2.) Clutch clip-on
- 3.) Slave cylinder



Spring L = 20.5 mm ± 0.2
Wire Dia = 3.8 mm

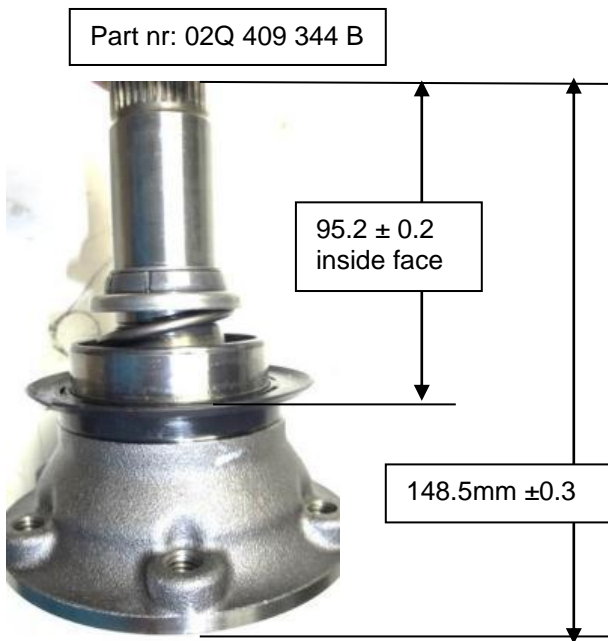

Long flange - Right



Short flange - Left

Part nr: 02Q 409 344 B

Part nr: 02M 409 343 E

95.2 ± 0.2
inside face

148.5mm ± 0.3

78.5 ± 0.2
inside face

113.5mm ± 0.3

26.9 A gearbox cooler kit is allowed as supplied by VW Motorsport.



Air inlet in front bumper



Cooler protection plate



Gearbox Pump.
Tilton 40-527



Cooler – 10 Row
Series 1M221

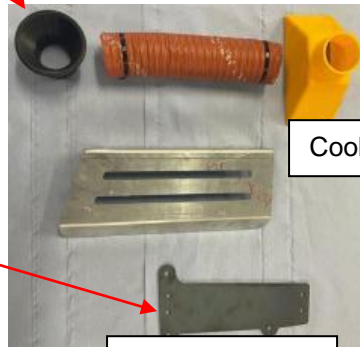

Cooler duct

Mounting plate

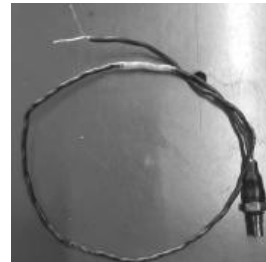

Temperature sensor
NTC1-M8-S-10K-050-193 or
TS-NTC3K-M8-14

Facelift – Standard bumper

Air inlet

Cooler Duct



**Facelift – Cars without
gearbox cooler, may have
the bumper insert without a
hole fitted.**

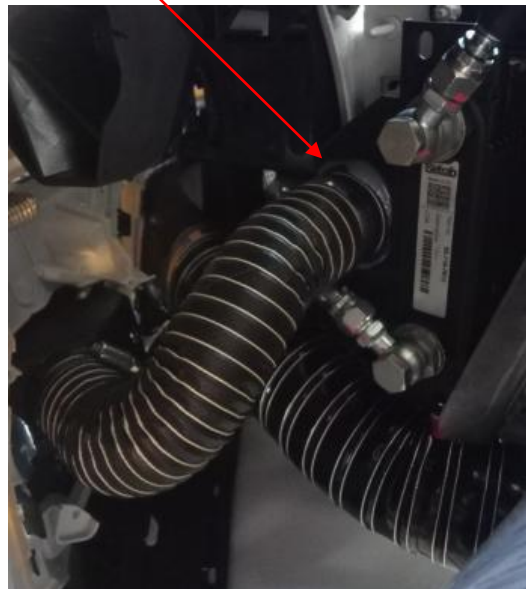

27. FINAL DRIVE FRONT

- 27.1. Make: VW
- 27.2. Type of diff: Limited Slip (Clutch ramp)
- 27.3. Limited slip: Yes
- 27.4. Ratio of diff: 3.75 (1st – 4th) & 3.0 (5th – 6th)
- 27.5. No. of teeth on crown wheel: 60
- 27.6. No. of teeth on pinion: 16 / 20

28. DRIVESHAFT

- 28.1. LHS Part #: 2Q0 407 271 BG
- 28.2. RHS Part #: 2Q0 407 272 BN



- 28.3. Outer CV joint cup maybe replaced by the bolt-type joint as supplied by VW Motorsport



29. INTERIOR

- 29.1. Inside covers and trim remain as supplied by VW Motorsport.
- 29.2. Airjack – It is allowed to install an airjack system. Provision has been made in the bodyshell.

Suggested layout



30. GENERAL

- 30.1 VENTS IN FRONT BUMPER
As per the below picture.



- 30.2 A stone protector for fitment to the lower bumper grille to protect the radiator is allowed.
Brake duct intakes, mounted in area as shown below.
A mesh may be fitted to the brake ducting opening.



Brake Duct inlets

- 30.3 The front grill area around the front VW Badge may also be covered to add protection for the radiator.



30.4 Rear bumper cut-out for exhaust tailpiece.



Facelift – Rear bumper

30.5 Front splitter board.



Thickness: 12mm \pm 0.5
Weight: 7.2 kg (Painted)

Splitter board height measured from splitter board, bottom face/plane, to ground is minimum 100mm.



Thickness: 12mm \pm 0.5
Weight: 5.0 kg (UnPainted)

30.6 Bonnet Vents



30.7 Fenders



30.8 Rear Wing & Brackets

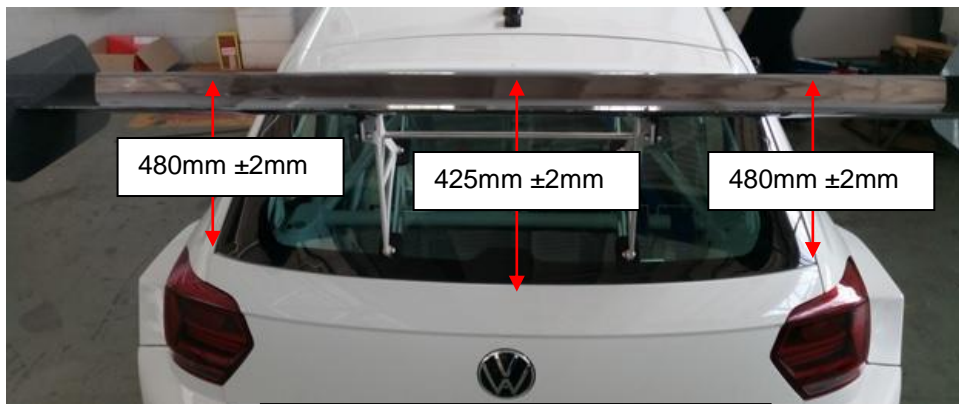

Wing set at highest position (top holes)

- 30.9. Front Headlight reinforcement brackets as supplied by VW Motorsport may be fixed to the headlight mounting brackets.



30.10. EXTERIOR TRIM, BADGES AND WINDOWS:

All exterior trim and badges are to remain on the car.

Tinting of windows will be allowed only on the side windows (4-doors) and the tint shade must be 35%

Rear windows are allowed to be opened by no more than 50mm if it is declared a wet race.

Windows are allowed to be secured to the door frame to prevent them coming out.

For improving ventilation inside the vehicle, NACA ducts may be fitted to the front and or rear window glass.

¼ Vent maybe be original glass as supplied or the Aluminium cover that makes provision for the endurance filler.



30.11 SAFETY NET:

A safety net covering the window opening on the driver's side is compulsory and must be fitted to the roll cage as supplied by Volkswagen Motorsport.

30.12 DRIVER'S SEAT and POSITION:

Vehicle is supplied with Sparco Seat and Seat Belts. (Other brands may be fitted)

The seat belts may not be mounted, to the same bolts as the driver's seat.

The position of the seat fore and aft in the car is free.

Only the mounting points welded to the car are permitted and the centralisation of the seat in relation to the standard mounting position must be respected.

Where extensions or spacers are required, permission from the Technical Consultants is required in writing.

30.13 INTERIOR TRIM:
The rear tailgate cover is optional.

31. ENGINE AND GEARBOX MOUNTINGS

Mountings are reinforced and supplied only by VW Motorsport.



32. BATTERY

32.1. The recommended battery is the KARIBA 646K and 643K that must be obtained from VW Motorsport. The batteries are available in two shapes. (depends on supplier stock)



32.2. Location: The battery is situated inside the battery box, which is mounted in the boot/spare wheel well area.

32.3. Battery box material is fibreglass or plastic and the shapes differ. Fixing brackets remain the same



33. SUBFRAME AND WHISHBONES

33.1. The only subframe allowed is the modified part from VW Motorsport

33.2. The only wishbones allowed is the modified part from VW Motorsport



34. REAR AXLE

- 34.1. The rear axle hanger brackets are sealed to the chassis and may only be removed after consulting the TC.

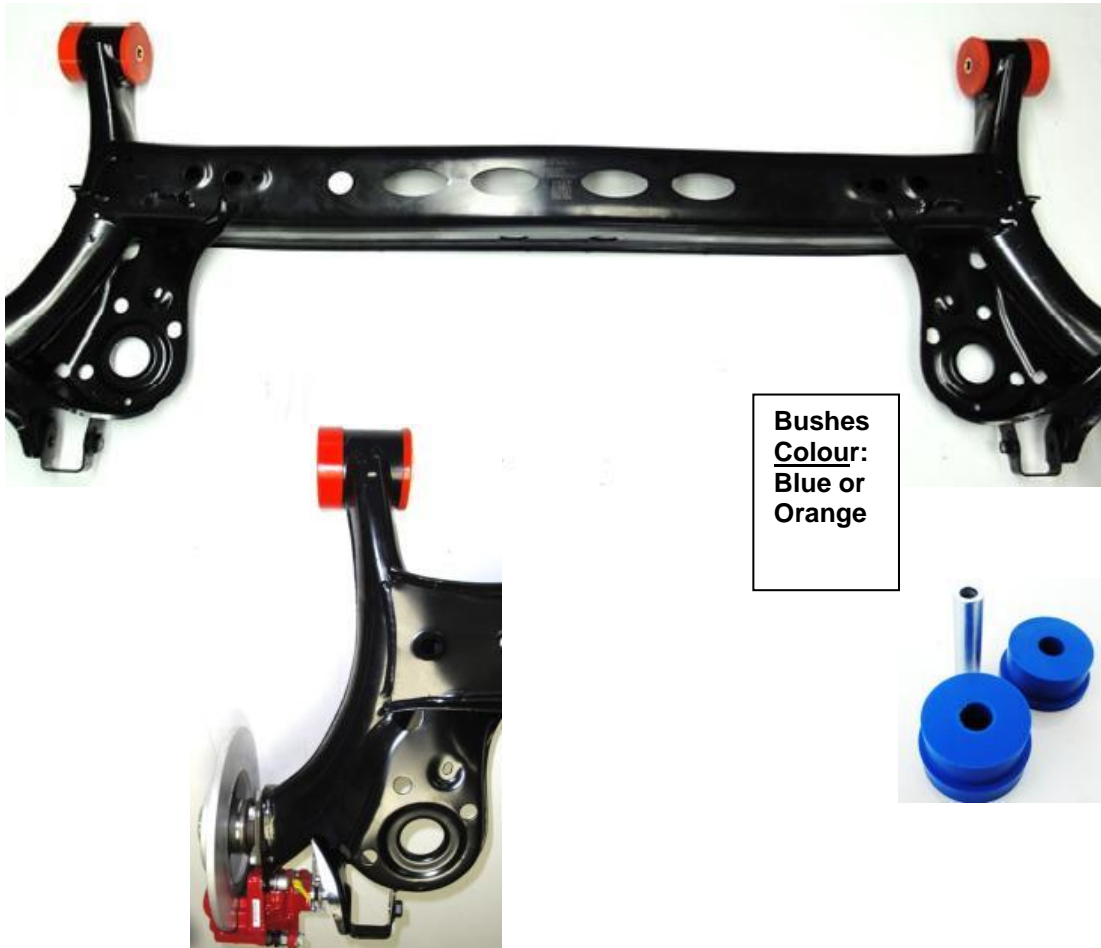

35. GEARSHIFTER KIT



Different paddle levers available.



36. FIRE EXTINGUISHER

36.1 The fire extinguisher is available in two colours, BLACK or RED and must comply too GCR257.

36.2 Recommended service for gauge type is, 1years (12 months)

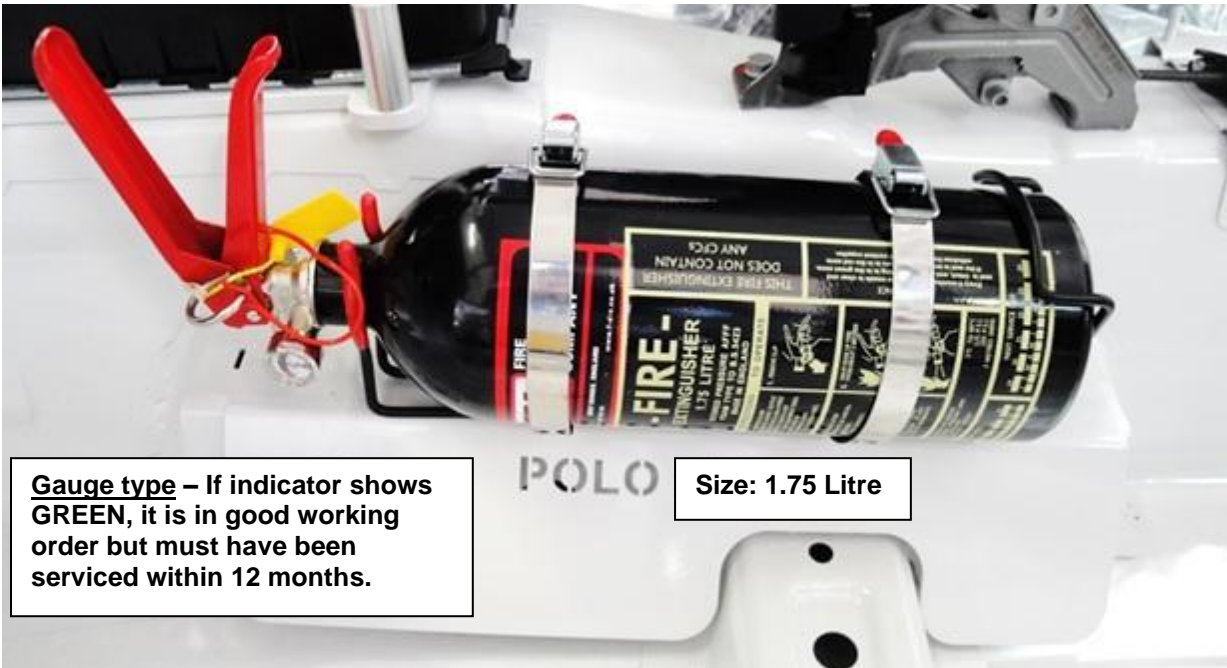

36.3 The SPA fire extinguisher is also allowed.



37. STEERING WHEEL

37.1. The original supplied “push-to-pass” button must be fitted.

The positioning on the steering wheel can be for driver comfort.

37.2. Steering boss extension is allowed and/or clip-on steering mechanism



38. ELECTRONICS

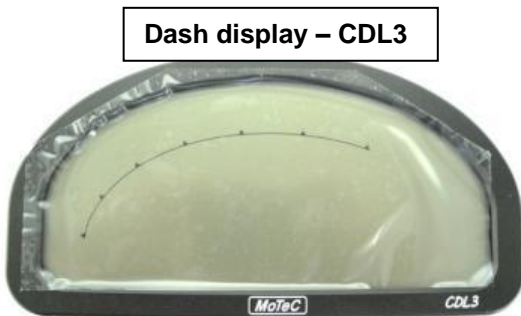
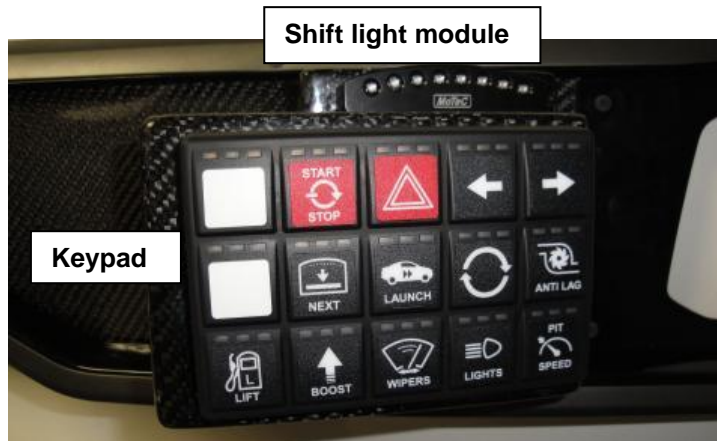

- 38.1. Wheelspeed sensors (x4), one per wheel, must be connected at all times.
- 38.2. Camera – In car camera/camera's type is FREE.
The recommended camera is the MoTec Model V2.
- 38.3. Push-to-Pass:
The Push to Pass strategy may be altered by the Technical Working Group and will be published as a Bulletin on the official Notice Board on the Friday of each event.
Push to Pass MAY NOT be used before the end of the first lap of any races, including restarts where the original grid is used.
Before means, any time before the first lap is completed of a race.
- Penalty:
1st lap of races – 10 seconds added to race time
- 38.4. Data Sharing: Refer to MSA National SATC SupaCup Sporting Regulations (163203) Article 22.2.2.
- 38.5. Pit to car communication:
Pit to car communication is allowed.
- 38.6. Launch control:
Launch control is deactivated and may be introduced if deemed necessary by Volkswagen Motorsport. This will be communicated by means of a Bulletin.
- 38.7 Balance of Performance
i) Maximum engine rpm not to exceed 6500 rpm.
ii) Engine output: The Maximum Absolute Manifold Pressure may not exceed the pressure created by the Boost Pressure Ratio Table as below.

RPM	2500	3000	3500	4000	4500	5000	5500	6000	6500	7000
Boost Ratio	1.800	1.800	1.800	1.836	1.871	1.907	1.943	1.943	1.900	1.800

The Maximum Absolute Manifold Pressure = boost ratio x 100 kPa

39. WEIGHT PLATES

- 39.1. Only weight plates supplied by VW Motorsport may be used and must be installed in area provided behind driver seat on the floor.



40. DECALS

See GTC Sporting regulations.
Point 6, 7 & 8

DECLARATION

In submitting this model for registration and homologation, I confirm that to the best to my knowledge and belief the data and information listed in this document are truly representative of a normal production unit.

SIGNED: *Michael Rowe*
FULL NAMES: MICHAEL ROWE
DESIGNATION: MOTORSPORT MANAGER
REPRESENTING: **VOLKSWAGEN MOTORSPORT**
DATE: 15.02.2025
DATA CHECKED BY: COBUS BARNARD

ACCEPTED FOR REGISTRATION BY MSA: _____

DATE: _____